

特点

- 芯片与底板电气绝缘，2500V交流电压
- 采用进口玻璃钝化芯片焊接，优良的温度特性进口和功率循环能力
- 体积小，重量轻

典型应用

- 变频器
- 交直流电机控制
- 各种整流电源

$I_{F(AV)}$	300A
V_{RRM}	500-2500V
I_{FSM}	12.5 KA
I^2t	797 $10^3 a^2s$

符号	参数	测试条件	结温 $T_J(°C)$	参数值			单位
				最小	典型	最大	
$I_{F(AV)}$	正向平均电流	180° 正弦半波, 50HZ 单面散热, $T_C=100°C$	150			300	A
$I_{F(RMS)}$	方均根电流		150			471	A
V_{RRM}	反向重复峰值电压	$V_{RRM} tp=10ms$ $V_{RSM}=V_{RRM}+200V$	150	500		2500	V
I_{RRM}	反向重复峰值电流	$V_{RM}=V_{RRM}$	150			20	mA
I_{FSM}	正向不重复浪涌电流	10ms 底宽, 正弦半波 $V_R=0.6V_{RRM}$	150			12.5	KA
I^2t	浪涌电流平方时间积					797	A^2S*10^3
V_{FO}	门槛电压		150			0.75	V
r_F	斜率电阻					0.55	$m\Omega$
V_{FM}	正向峰值电压	$I_{FM}=900A$	25			1.30	V
$R_{th(j-c)}$	热阻抗 (结至壳)	180° 正弦波, 单面散热				0.130	$°C/W$
$R_{th(c-h)}$	热阻抗 (壳至散)	180° 正弦波, 单面散热				0.04	$°C/W$
V_{iso}	绝缘电压	50Hz, R.M.S, $t=1min, I_{iso}: 1mA(max)$		2500			V
F_M	安装扭矩 (M5)				12		N-m
	安装扭矩 (M6)				6		N-m
T_{stq}	储存温度			-40		125	$°C$
W_t	质量				860		g
Outline	外形						

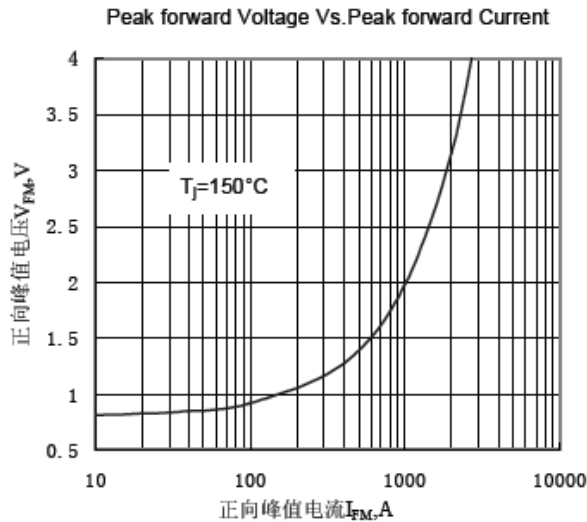

Fig.1 正向伏安特性曲线

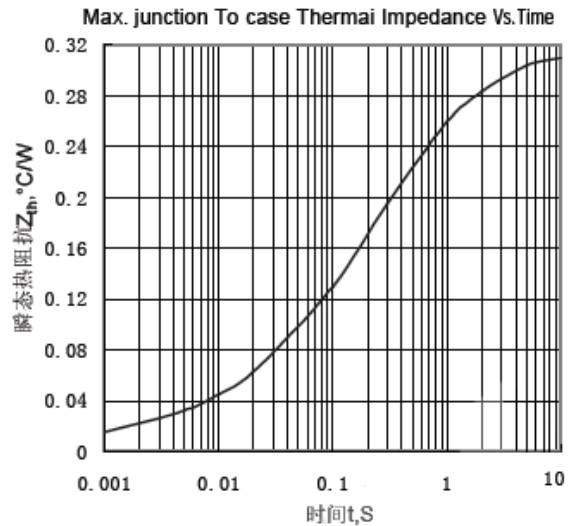

Fig.2 瞬态热阻抗曲线

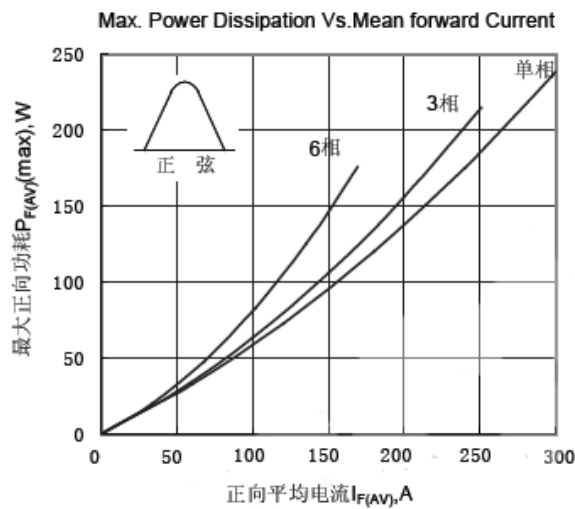

Fig.3 最大正向功耗与平均电流关系曲线

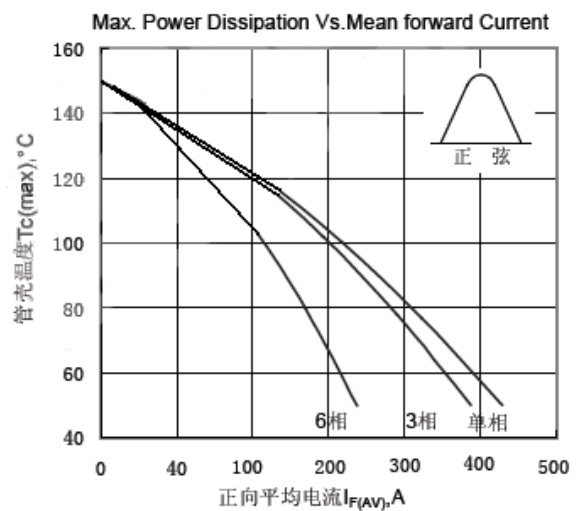

Fig.4 管壳温度与正向平均电流关系曲线

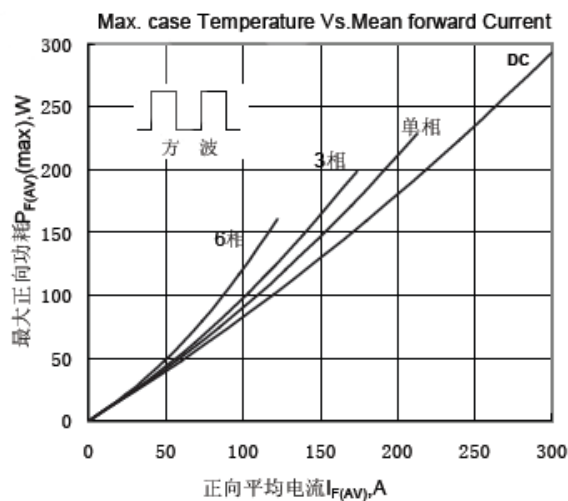

Fig.5 最大正向功耗与平均电流关系曲线

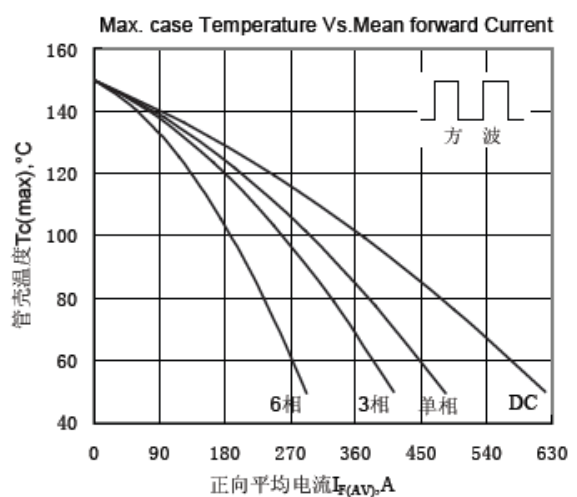

Fig.6 管壳温度与正向平均电流关系曲线

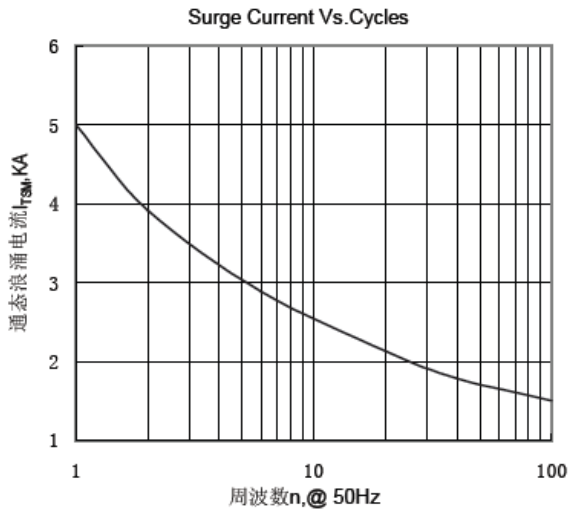

Fig.7 通态浪涌电流与周波数的关系曲线

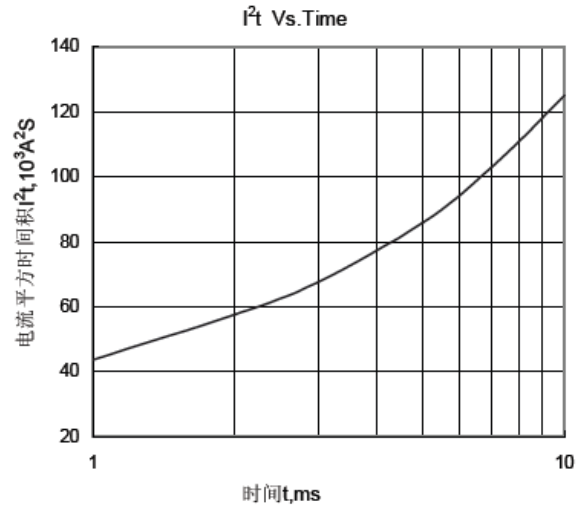

Fig.8 I^2t 特性曲线

外形图:



图 1



图 2

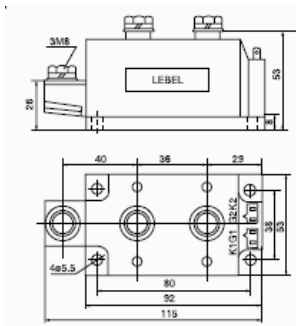

图 3

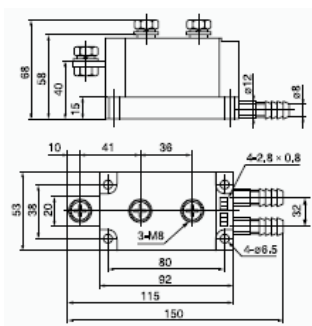

图 4

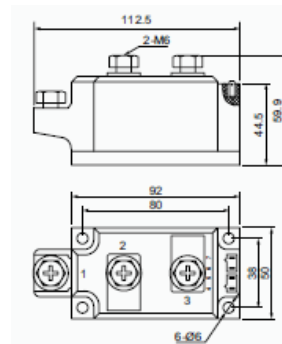

图 5

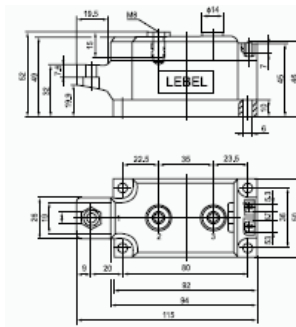

图 6

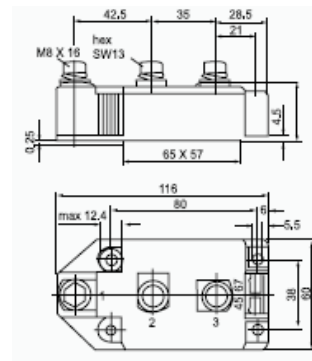

图 6

线路图:

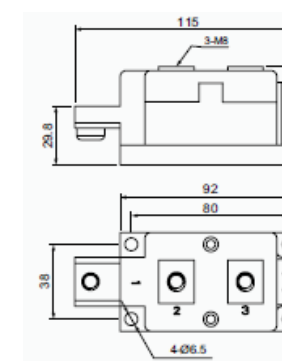
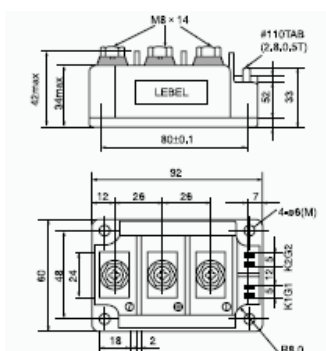